

omporro 

officine meccaniche porro



ALFREDO  
PORRO



MANUFACTURED BY OFFICINE MECCANICHE PORRO

COMPLEMENTI D'ARREDO IN METALLO NOBILE





officine meccaniche porro

## ARTIGIANI DELL'ECCELLENZA

Nel 1946, dal laboratorio di Alfredo Porro, nasce Officine Meccaniche Porro e quello che era un laboratorio artigiano acquista le dimensioni di un'Azienda senza mai perdere la sua vocazione artigianale.

Negli anni '70 sarà il figlio Giuseppe ad allargare la gamma di prodotti di grande qualità concepiti e creati con passione, esteticamente pregevoli e tecnologicamente sempre all'avanguardia.

Tutti valori che sono passati anche alla terza generazione della famiglia: Fabio, Donata e Paola che continuano ad offrire una produzione in cui qualità, passione artigianale, estetica e la miglior tecnologia disponibile ben rappresentano l'Eccellenza Italiana in oltre 80 Paesi nel mondo.

## EXCELLENCE IN CRAFTSMANSHIP

In 1946, Alfredo Porro transformed his workshop into Officine Meccaniche Porro, effectively turning a craft laboratory into a corporate endeavor that, however, never lost its artisanal roots.

In the 1970s, Alfredo's son, Giuseppe, broadened the range of high-quality, aesthetically valuable and technologically advanced products designed and created with passion.

These values have been passed on to the Porro Family's third generation: Fabio, Donata and Paola continue to offer today products whose quality, artisanal passion, aesthetics and state-of-the-art technology well represent Italian Excellence in more than 80 countries.

**ALFREDO  
PORRO**



MANUFACTURED BY OFFICINE MECCANICHE PORRO

## COMPLEMENTI D'ARREDO IN METALLO NOBILE

Il marchio, dedicato al nostro fondatore, contraddistingue la nostra produzione di complementi per mobili, tende e scale in cui la qualità delle materie prime, la funzionalità e l'aspetto decorativo raggiungono livelli estremamente elevati.

Oggetti curati nel dettaglio, solidi e destinati a durare nel tempo e un gran numero di referenze, di stili, di materiali e di finiture che possono soddisfare ogni esigenza e completare, coerentemente, la nostra offerta di maniglie.

## NOBLE METAL ACCESSORIES

Our brand, dedicated to our founder, defines our production of accessories for furniture, curtains and stairs whose raw material quality, functionality and decorative aspect reach extremely high levels. Solid, durable and carefully detailed items, as well as a large number of references, styles, materials and finishes that can meet any expectation and complete our range of handles.

**ENRICO CASSINA**

MANUFACTURED BY OFFICINE MECCANICHE PORRO

## MANIGLIERIA DI PREGIO DAL 1850

Il prestigioso marchio Enrico Cassina rappresenta l'apice della qualità e dello stile nella maniglieria.

Veri «pezzi d'arte» artigianali nella purezza stilistica che va dal Barocco al Contemporaneo e che consente di completare coerentemente qualsiasi progetto architettonico o di interior design.

Prodotti unici e ricercati presenti nelle ville e negli hotel più prestigiosi in oltre 80 Paesi nel mondo e che, come tutta la produzione Officine Meccaniche Porro, sono garantiti 100% Made in Italy.

## PRESTIGIOUS DOOR HANDLES SINCE 1850

The prestigious Enrico Cassina brand represents the pinnacle of quality and style in door handles. True artisanal "art pieces" whose style ranges from the Baroque to Contemporary themes, and allows completing any architectural or interior design project. Unique and sophisticated products installed in the most prestigious villas and hotels in more than 80 countries, and which, like all Officine Meccaniche Porro production, are guaranteed, 100% Made-in-Italy creations.

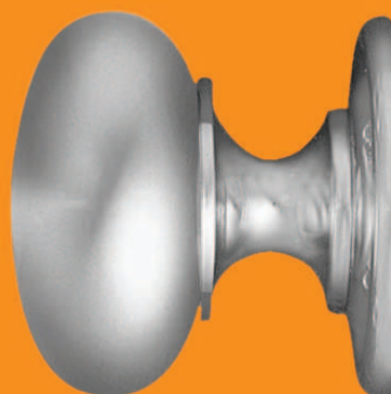

IL PERFETTO  
INCONTRO  
TRA INDUSTRIA  
E DESIGN

THE PERFECT  
MATCH BETWEEN  
MANUFACTURING  
AND DESIGN

# ALFREDO PORRO



MANUFACTURED BY OFFICINE MECCANICHE PORRO

In occasione del settantesimo anno di vita delle Officine Meccaniche Porro, Fabio, Donata e Paola Porro hanno voluto dedicare al nonno Alfredo la gamma di complementi d'arredo per mobili, tende e scale.

È nel 1946, infatti, che Alfredo Porro compie il grande passo, da bottega artigiana per la riproduzione di chiavi fonda le Officine Meccaniche Porro.

L'Officina di Cantù - rinominata Officine Meccaniche Porro - diventa presto punto di riferimento per i più importanti mobilifici e falegnamerie della zona, la Brianza, ovvero quella zona a nord di Milano che è famosa proprio per la produzione di mobili e infissi.

La qualità delle materie prime utilizzate e delle lavorazioni, spesso rifinite a mano una ad una, non si discutono. Alfredo Porro poteva rompere un'amicizia decennale per il suggerimento di utilizzare la zama, lega povera e meno costosa dell'ottone ma con la stessa resa estetica, la sua filosofia era «qualità» prima di tutto.

Il figlio Giuseppe affiancherà il padre per poi prendere le redini dell'Azienda e, oggi, è la terza generazione della Famiglia Porro che continua una produzione contraddistinta da qualità delle materie prime, cura artigianale nelle lavorazioni, ricerca di sempre migliori tecnologie.

In Officine Meccaniche Porro, oggi come nel 1946, anche il più piccolo pomolino deve essere fatto al meglio e con i migliori prodotti utilizzabili.

Tutti prodotti del marchio Alfredo Porro sono 100% Made in Italy, garanzia di alta qualità, attenzione al dettaglio e design impeccabile. In sintesi: tutti i prodotti Alfredo Porro possono fregiarsi, senza tema di smentita, del titolo di prodotti dell'Eccellenza Italiana nel mondo.

On the occasion of Officine Meccaniche Porro's 70th birthday, Fabio, Donata and Paola Porro dedicated to grandpa Alfredo a complete catalog of accessories for furniture, curtains and stairs.

It was 1946, indeed, when Alfredo Porro made the big leap, transforming his artisan workshop into Officine Meccaniche Porro.

The Cantù facilities, renamed Officine Meccaniche Porro, became a reference point for the most important furniture makers and carpenters of the Brianza region, an area north of Milan famous for the production of furniture, as well as windows and doors.

The quality of the raw materials used and the handiwork were, and still are, unquestionable. For his creations and in honor of his "quality-above-all" philosophy, Alfredo Porro chose to use brass over zinc alloy, which, though cheaper than and similar in appearance to brass, was qualitatively weaker.

Giuseppe Porro joined his father, eventually taking the company's helm, which is today held by the family's third generation. Production continues, always distinguished by the high quality of raw materials, accurate handiwork and search of the best technology.

Today, as in 1946, at Officine Meccaniche Porro even the smallest knob must be perfect, so it is made using the best materials available.

All Alfredo Porro brand products are 100% Made in Italy. They guarantee top quality, care in every detail and impeccable design.

In short: all Alfredo Porro products can unquestionably claim to embody Italian Excellence in the world.



MANIGLIE PER MOBILE CABINET HANDLES	pag page	5
POMOLI PER MOBILE CABINET KNOBS	pag page	15
BOCCHETTE PER MOBILE CABINET ESCUTCHEONS	pag page	21
CHIAVI PER MOBILE CABINET KEYS	pag page	23
CHIAVI PER MOBILE Archivio Alfredo Porro CABINET KEYS FROM Alfredo Porro Archive	pag page	26
FREGI E CIMASE CABINET DECORATIONS	pag page	34
CERNIERE E CATENELLE MOBILE CABINET HINGES AND CABINET CHAINS	pag page	42
PUNTALI E PIEDINI PER MOBILE CABINET FEET	pag page	45
GANCI HOOKS	pag page	47
ACCESSORI TENDE E SCALE CURTAINS AND STAIRS ACCESSORIES	pag page	49
RELING RELING	pag page	64
MANIGLIE INCASSO FLUSH HANDLES	pag page	69
MANIGLIE VETRO HANDLES FOR GLASS DOORS	pag page	75
APPENDIABITI E PORTACHIAVI COAT HANGERS AND HOTEL KEY-RINGS	pag page	78
REGGIPENSILI E REGGIMENSOLE WALL BRACKETS AND SHELF BRACKETS	pag page	81
ACCIAIO INOX STAINLESS STEEL	pag page	84
ALLUMINIO ALUMINIUM	pag page	88
ACCESSORI ACCESSORIES	pag page	92

A kitchen with white cabinetry, a dark wood island with red leather chairs, and two glass pendant lights. The kitchen features white shaker-style cabinets with silver handles, a white subway tile backsplash, and a dark wood island with a white base. Three red leather bar stools are tucked under the island. A glass bowl of fruit sits on the island. A window above the sink shows a view of the outdoors. A blue and white vase is on the counter to the left. The ceiling has recessed lighting and two glass pendant lights hanging from the island.

# MANIGLIE PER MOBILE CABINET HANDLES

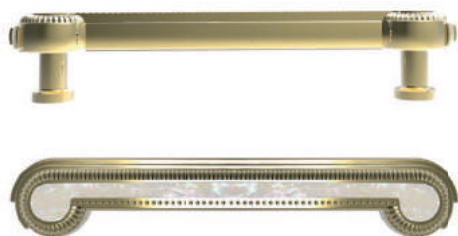

**C03090**  
**128** (160x30)  
**160** (192x30)



**C03090 SW**  
**128** (160x30)  
**160** (192x30)



**C02990**  
**128** (164x15)  
**192** (228x15)  
**320** (356x15)



**C17890**  
**96** (134x18)  
**128** (166x18)



**C09590**  
**96** (108x14)  
**120** (140x14)





**461**  
**96** (147x12)  
**160** (208x14)



**406**  
**96** (125x20)  
**160** (200x22)



**C10190**  
**128** (143x16)  
**192** (207x16)  
**320** (335x16)

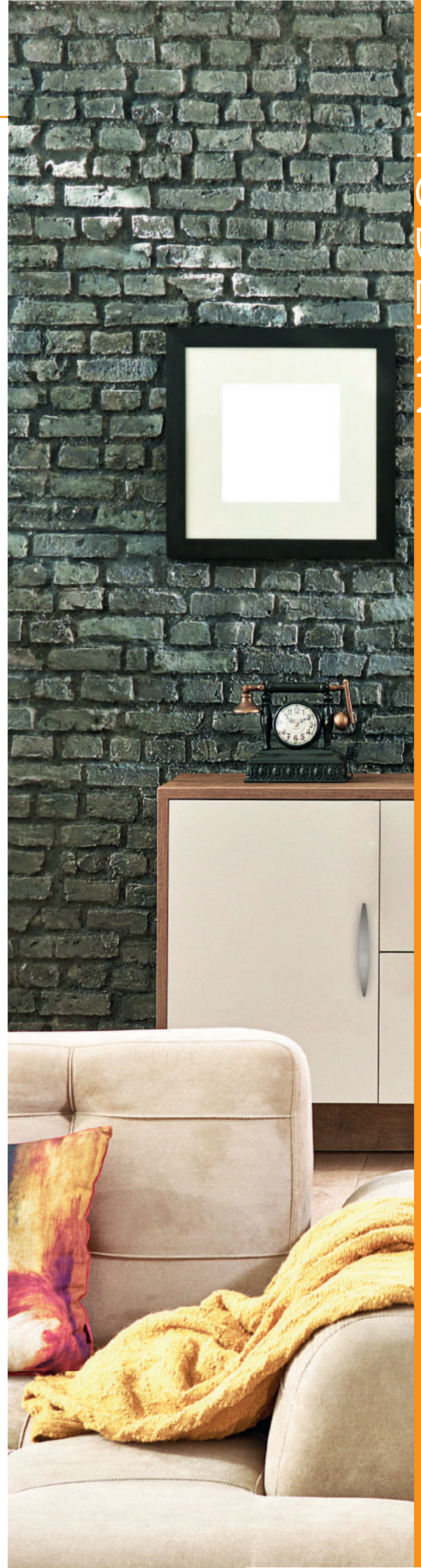



**529**  
64 (130x64)



**526**  
64 (92x25)  
32 (46x25)



**530**  
64 (120x32)



**464**  
96 (136x39)  
128 (168x39)  
160 (200x39)  
192 (232x39)  
320 (360x39)  
480 (520x39)



**538 V**  
160 (14x174)  
192 (14x206)  
256 (14x270)



MODERN



**400**  
**32** (42x9)  
**64** (78x11)  
**96** (110x11)



**451**  
**64** (100x26)  
**96** (144x34)



**454**  
**64** (92x39)



**472**  
**64** (83x36)  
**96** (96x115)



**522**  
**64** (81x11)  
**96** (121x15)  
**192** (215x15)



**489**  
**75** (81x43)  
**100** (97x54)



**499**  
**34** (34x37)  
**40** (40x43)  
**50** (50x53)

CLASSIC





**440**  
**64** (68x26)  
**72** (85x32)  
**100** (113x42)  
**115** (128x47)



**441**  
**96** (110x36)



**465**  
**80** (81x46)  
**100** (101x60)



**466**  
**60** (58x48)



**422**  
 (35x64)



**443**  
**72** (96x39)  
**100** (133x52)



**424**  
**50** (28x68)  
**70** (34x92)



**467**  
**50** (22x61)



**425**  
**95** (24x107)  
**120** (30x136)



**420**  
**75** (103x41)  
**95** (129x52)



**423**  
**90** (91x29)  
**130** (129x34)  
**190** (194x51)  
**240** (244x51)



**650**  
**32** (Ø32)  
**39** (Ø39)  
**46** (Ø46)



**433**  
**50** (50x53)





**645**  
**32** (31x48)  
**43** (43x66)



**432**  
**96** (127x46)



**456**  
**100** (101x28)  
**140** (141x41)



**435**  
**100** (100x37)  
**125** (120x42)  
**160** (160x52)  
**210** (201x68)



**470**  
**90** (88x22)  
**120** (119x35)



**413**  
**65** (82x30)  
**80** (102x38)  
**90** (112x41)



**412**  
**65** (83x33)  
**80** (102x40)  
**90** (114x45)



**POMOLI PER MOBILE**  
**CABINET KNOBS**





**C03090\_PO**  
 Ø30 (h 24)  
 Ø40 (h 32)



**C03090\_PO SW**  
 Ø30 (h 24)  
 Ø40 (h 32)



**C17890\_PO**  
 30 (33x19)  
 42 (42x24)



**C02990\_PO**  
 (15x30)



**AL0192**  
 15 (22x15)  
 20 (30x20)



**165**  
 15 (15x20)  
 20 (20x27)  
 25 (25x33)  
 30 (30x39)  
 35 (35x45)



**AI0153**  
 15 (15x22)  
 18 (18x24)  
 21 (21x27)



**153**  
 12 (12x19)  
 15 (15x22)  
 18 (18x24)  
 21 (21x27)  
 25 (25x32)



**105**  
 25 (25x15)  
 30 (30x20)  
 35 (34x23)



**151**  
 25 (25x23)  
 30 (30x27)



**461 P**  
 48 (21x48)



**AI0181**  
**20** (20x24)  
**24** (24x29)



**AI0180**  
**20** (20x22)  
**25** (25x27)  
**30** (30x32)



**523**  
**23** (18x30)



**170**  
**25** (25x25)  
**30** (30x30)  
**35** (35x35)



**141**  
**30** (30x26)  
**35** (35x31)  
**40** (40x35)



**158**  
**20** (20x20)  
**25** (25x25)  
**30** (30x30)  
**35** (35x33)  
**40** (40x33)

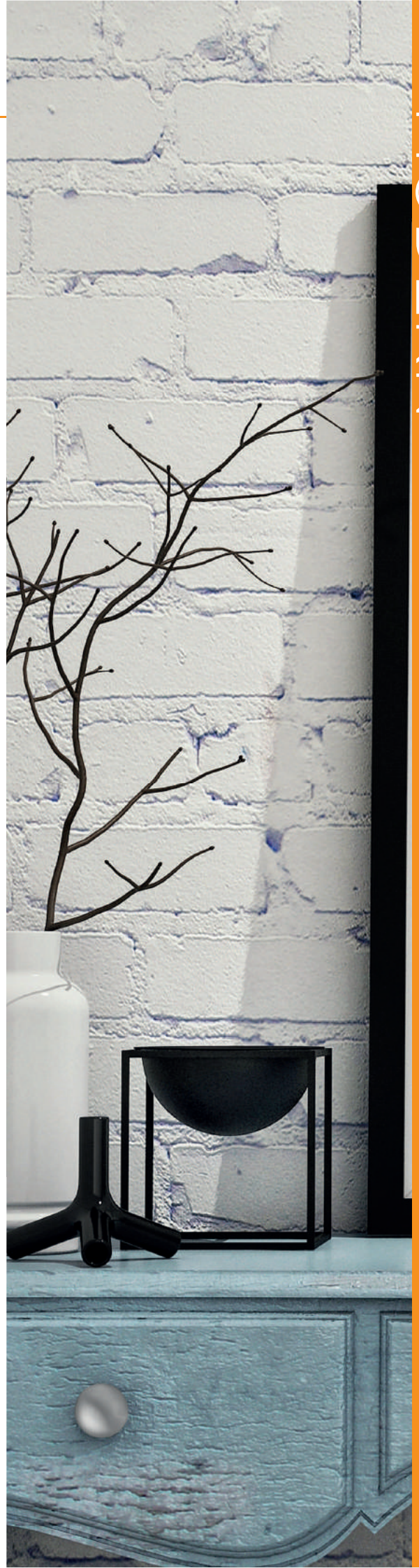



**160**  
**21** (20x19)  
**26** (25x21)  
**32** (32x23)  
**40** (40x26)



**100**  
**20** (20x18)  
**25** (25x22)  
**31** (31x28)



**101**  
**20** (20x16)  
**25** (25x20)  
**30** (30x23)



**142**  
**25** (25x19)  
**30** (30x22)  
**35** (35x25)



**163**  
**30** (21x30)  
**35** (24x35)  
**40** (28x40)



**161**  
**17** (17x17)  
**21** (20x20)  
**26** (25x23)  
**32** (32x26)  
**40** (40x29)



**145**  
**25** (25x22)  
**30** (30x25)  
**40** (39x31)



**146**  
**25** (25x19)  
**30** (30x22)  
**40** (39x27)  
**55** (55x36)





**102**  
**25** (25x24)  
**30** (30x28)  
**40** (40x37)



**164**  
**25** (25x18)  
**30** (30x22)  
**35** (35x25)  
**40** (40x28)



**168**  
**25** (26x26)  
**30** (30x30)  
**35** (35x35)



**140**  
**25** (25x17)  
**30** (30x18)  
**35** (34x19)



**130**  
**15** (15x16)  
**20** (20x18)  
**25** (25x22)  
**30** (30x26)  
**35** (35x30)



**135**  
**30** (30x23)  
**35** (35x27)



**120**  
**25** (25x21)  
**30** (31x23)  
**35** (35x29)

# BOCCHETTE PER MOBILE CABINET ESCUTCHEONS





**C17890\_BO**  
(24x42)



**336**  
Ø25  
Ø30  
Ø35



**332**  
(18x35)



**300**  
**29** (20x29)  
**37** (26x37)  
**47** (32x47)



**421**  
Ø33



**437**  
**85** (85x45)



**455**  
**55** (36x55)



**310V dx/sx**  
**90** (16x90)  
**170** (25x166)



A large, ornate white wooden cabinet with glass doors and drawers, set in a bright dining room with a window and plants. The cabinet features a curved top, glass-fronted upper cabinets with decorative knobs, and a lower section with drawers and solid doors. A floral-patterned bread box sits on the countertop. The room is bright, with a large window showing trees and a white chair near a table with a lace tablecloth. A stone wall is visible on the right.

# CHIAVI PER MOBILE CABINET KEYS



**15**  
**30** (26x66)  
**40** (26x76)  
**45** (26x81)



**74**  
**30** (30x62)  
**40** (30x72)



**28**  
**30** (35x61)  
**40** (35x71)



**33**  
**30** (27x56)  
**35** (27x61)  
**40** (27x66)  
**45** (27x71)



**55**  
**35** (26x68)  
**45** (26x78)



**48**  
**32** (20x64)  
**42** (20x74)



**45**  
**35** (28x68)  
**42** (28x75)



**30**  
**33** (35x62)  
**42** (35x73)



**30 T**  
 (35x32)



**26**  
**30** (28x60)  
**35** (28x65)  
**40** (28x70)  
**45** (28x75)



**26 T**  
 (28x30)



**44**  
**33** (23x67)  
**45** (23x79)



**41**  
**35** (29x70)  
**45** (29x80)



**17**  
**30** (31x72)  
**38** (31x80)



**29**  
**33** (32x79)  
**42** (32x88)



**16**  
**30** (33x74)  
**40** (33x84)



QUANTITATIVO MINIMO D'ORDINE:  
1000 PEZZI, SUDDIVISI IN  
TRE FINITURE DIFFERENTI

MINIMUM ORDER QUANTITY:  
1000 PIECES EACH REFERENCE, SUBDIVIDED INTO  
MAXIMUM THREE DIFFERENT FINISHES



**78**  
**30** (36x51)  
**40** (36x61)



**76**  
**30** (31x61)  
**40** (31x71)



**67**  
**30** (30x60)  
**40** (30x70)



**9**  
**30** (35x47)  
**40** (35x57)  
**50** (35x67)



**59 M**  
**25** (36x54)  
**35** (36x64)



**59**  
**25** (36x54)  
**35** (36x64)  
**42** (36x71)



**11**  
**40** (33x56)  
**50** (33x68)



**32**  
**27** (28x50)  
**35** (28x58)  
**42** (28x65)



**10**  
**23** (31x66)  
**33** (31x76)  
**42** (31x85)



**60**  
**25** (36x49)  
**35** (36x59)



**22**  
**33** (32x63)  
**45** (32x73)



**56**  
**25** (24x49)  
**35** (24x59)  
**45** (24x69)



**27 M**  
**34** (26x70)



**60 M**  
**25** (36x46)  
**35** (36x56)

QUANTITATIVO MINIMO D'ORDINE:  
1000 PEZZI, SUDDIVISI IN  
TRE FINITURE DIFFERENTI

MINIMUM ORDER QUANTITY:  
1000 PIECES EACH REFERENCE, SUBDIVIDED INTO  
MAXIMUM THREE DIFFERENT FINISHES



**39**  
**30** (28x66)  
**35** (28x71)  
**40** (28x76)



**37**  
**25** (23x48)  
**30** (23x53)  
**35** (23x58)



**15 T**  
(26x36)



**55 T**  
(26x33)



**40 M**  
**30** (28x66)



**48 T**  
(20x32)



**35**  
**30** (33x71)  
**40** (33x81)



**75**  
**30** (28x58)  
**40** (28x68)

QUANTITATIVO MINIMO D'ORDINE:  
1000 PEZZI, SUDDIVISI IN  
TRE FINITURE DIFFERENTI

MINIMUM ORDER QUANTITY:  
1000 PIECES EACH REFERENCE, SUBDIVIDED INTO  
MAXIMUM THREE DIFFERENT FINISHES



**24**  
**30** (34x59)  
**40** (34x69)



**38**  
**30** (33x79)  
**40** (33x89)



**38 T**  
(33x49)



**2**  
**35** (35x73)  
**45** (35x83)



**26 M**  
**30** (28x60)



**68**  
**40** (34x70)



**34 M**  
**27** (27x50)  
**37** (27x60)



**53**  
**35** (39x69)



**44 T**  
(23x33)





**54 T**  
(29x27)



**47**  
**25** (21x58)  
**35** (21x68)  
**42** (21x75)



**57 T**  
(25x36)



**54**  
**23** (29x50)  
**32** (29x59)  
**42** (29x69)



**47 T**  
(21x33)



**57**  
**25** (25x61)  
**35** (25x71)  
**45** (25x81)

QUANTITATIVO MINIMO D'ORDINE:  
1000 PEZZI, SUDDIVISI IN  
TRE FINITURE DIFFERENTI

MINIMUM ORDER QUANTITY:  
1000 PIECES EACH REFERENCE, SUBDIVIDED INTO  
MAXIMUM THREE DIFFERENT FINISHES



**12**  
**23** (39x54)  
**32** (39x63)  
**42** (39x73)



**69**  
**32** (38x73)  
**42** (38x83)



**71**  
**32** (50x70)  
**42** (50x80)



**1**  
**35** (29x74)  
**45** (29x84)



**52 T**  
(28x41)



**52**  
**23** (28x63)  
**33** (28x74)  
**42** (28x83)



**16 M**  
**30** (33x74)



**16 T**  
(33x44)



**29 T**  
(32x47)



**17 T**  
(31x41)



**17 M**  
**25** (31x67)  
**35** (31x77)



**25**  
**32** (33x75)  
**42** (33x85)



**49**  
**35** (32x76)  
**45** (32x82)



**43 T**  
(28x45)



**43**  
**33** (27x78)  
**42** (27x87)



**73**  
**30** (32x72)  
**40** (32x82)



An ornate, white-painted cabinet with intricate gold leaf decorations is the central focus. The cabinet features a large, oval-shaped medallion on its front, surrounded by elaborate scrollwork and a central mask-like motif. The sides of the cabinet are decorated with a repeating diamond lattice pattern. The legs are also highly decorative, with a central leg featuring a large, carved floral element. The cabinet is set in a room with dark wood paneling and a large window with white curtains. A matching ornate chair with a yellow seat is positioned to the left of the cabinet. The floor is made of light-colored wood in a herringbone pattern. The text "FREGI E CIMASE" is overlaid in white, and "CABINET DECORATIONS" is overlaid in orange below it.

**FREGI E CIMASE**  
**CABINET DECORATIONS**



**207**  
**48** (48x33)  
**70** (70x50)



**208**  
**30** (42x42)  
**40** (56x56)



**348**  
(232x67)



**347**  
(260x77)



**344**  
(167+48+167)x35



**209**  
Ø36



**210**  
Ø35



**211**  
Ø48



**212**  
Ø43



**1071**  
**160** (33x166)  
**210** (37x216)



**200**  
Ø19  
Ø24  
Ø28  
Ø33  
Ø42



**343**  
(22x166)



**342**  
(71x147)



**331**  
(60x71)



**333**  
(48x58)



**334**  
(88x92)





**303**  
(158x29)



**302**  
(240x47)



**335**  
(30x158)



**329**  
(87x131)



**213**  
Ø46





**345**  
(69+46+69)x46



**346**  
(104+46+104)x46

CIMASE CABINET DECORATIONS



**1070**  
**130** (31x131)  
**140** (40x140)  
**230** (54x226)



**1063 CM**  
 (48x182)



**1064 CM**  
 (43x154)



**1062 CM**  
 (37x206)

FREGI PER PIEDINO MOBILE DECORATIONS FOR CABINET FEET



**1063 PI**  
 (28x87)



**1060**  
 (35x98)



**1061**  
 (31x81)



**1064 PI**  
 (36x91)



**1062 PI**  
 (46x117)



CLASSIC

**CERNIERE E  
CATENELLE MOBILE  
CABINET HINGES  
AND CABINET CHAINS**

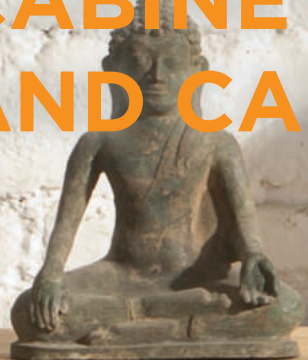



**473 BIS**  
(48x66)



**473**  
(57x65)



**473 BA**  
(57x65)



**474**  
**63** (35x63)  
**75** (35x76)



**760 CG**

- 150
- 200
- 250
- 300
- 350
- 400
- 500



**760 FS**

- 150
- 200
- 250
- 300
- 350
- 400
- 500



**761**

- 150
- 200
- 250
- 300
- 350
- 400
- 500



**PUNTALI E PIEDINI  
PER MOBILE  
CABINET FEET**

PUNтали E PIEDINI PER MOBILE CABINET FEET

PUNтали CABINET FEET



**1015**  
**25** (33x32)  
**30** (39x37)  
**35** (44x40)



**1010**  
**21** (28x24)  
**23** (31x26)  
**25** (34x28)  
**30** (41x32)  
**35** (46x35)

PIEDINI CABINET FEET



**1026**  
**100** (40x100)  
**150** (40x150)



**1025**  
**100** (32x100)  
**150** (32x150) \*



**1029**  
**100** (32x100)  
**150** (32x150)



**1040**  
**120** (32x120)  
**150** (32x150) #



**AP01\***  
**65** (126x95)



**AP02\***  
**60** (60x60)



**AP04 #**  
**72** (72x25)

\* # : Prodotti abbinabili anche con: \* #  
 \* # : Products also combinable with: \* #



**GANCI**  
**HOOKS**





**1505**

- 20** (22x18)
- 28** (29x22)
- 35** (35x27)
- 42** (42x32)
- 50** (51x38)



**1509**

- 25** (10x25)
- 35** (13x35)
- 45** (17x45)



**1506**

- 20** (25x34)
- 28** (32x24)
- 35** (38x27)
- 42** (45x33)
- 50** (54x33)



**1510**

- 30** (15x30)
- 50** (23x45)
- 75** (35x75)
- 100** (46x100)



**1520**

- 30** (18x30)
- 50** (30x53)
- 75** (45x86)
- 100** (60x115)

**ACCESSORI  
TENDE E SCALE  
CURTAINS AND STAIRS  
ACCESSORIES**

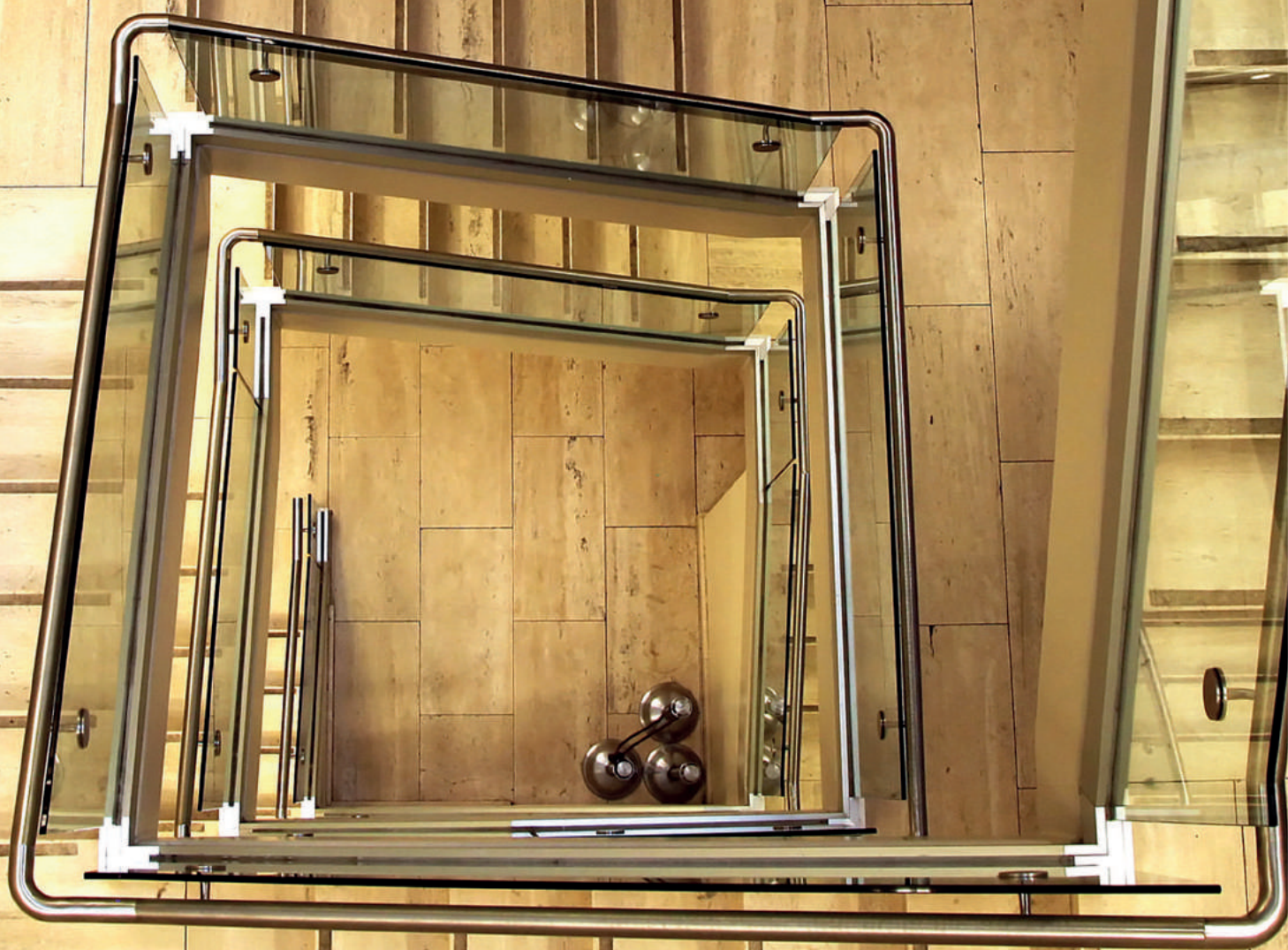

SUPPORTI TENDA CURTAINS BRACKETS

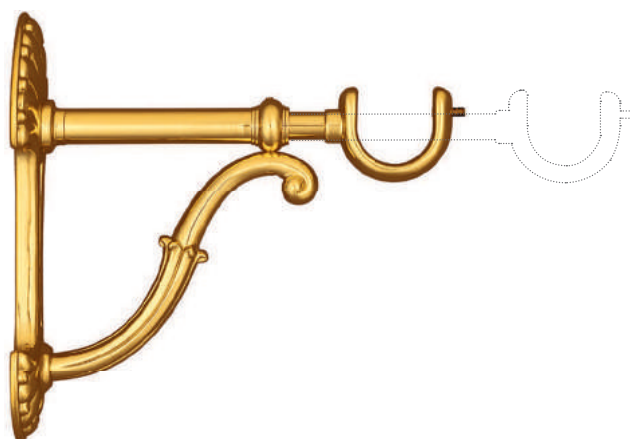

**800**  
**Ø25** (160/240x173)      **Ø25** (220/290x173)  
**Ø30** (163/240x173)      **Ø30** (223/293x173)  
**Ø35** (165/240x173)      **Ø35** (225/295x173)

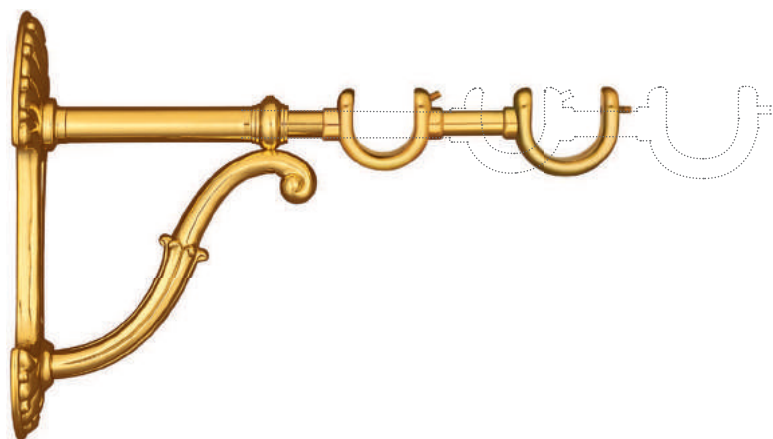

**800 D**  
**Ø25/Ø30** (242/322x173)

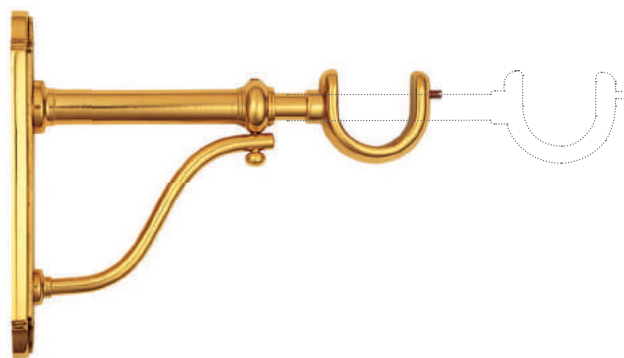

**867**  
**Ø30** (163/240x140)  
**Ø30** (223/293x140)  
**Ø35** (165/240x140)  
**Ø35** (225/295x140)

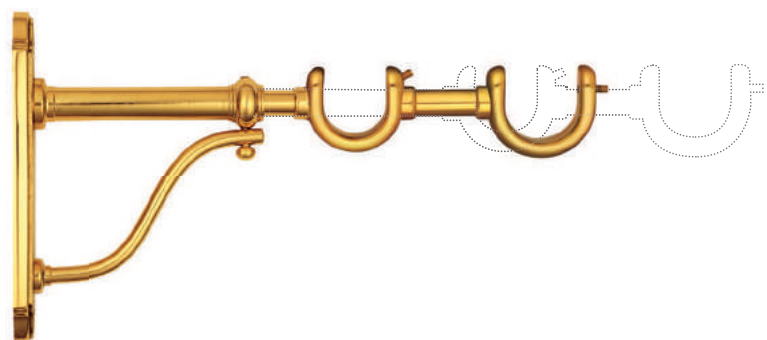

**867 D**  
**Ø25/Ø30** (242/322x142)

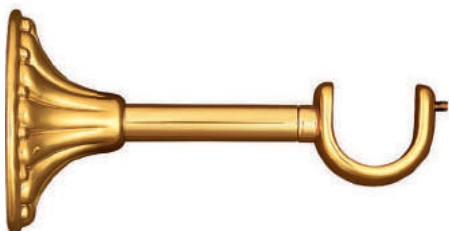

**801**  
**Ø25x120** (151x84)      **Ø30x120** (157x84)  
**Ø25x180** (211x84)      **Ø30x180** (217x84)  
**Ø25x240** (267x84)      **Ø30x240** (273x84)  
**Ø35x120** (163x84)  
**Ø35x180** (223x84)  
**Ø35x240** (279x84)

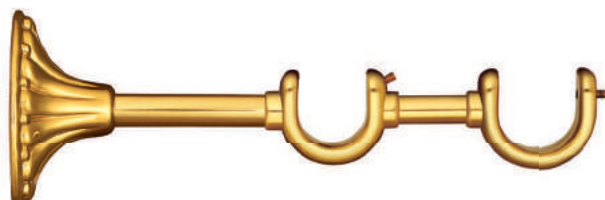

**801 D**  
**Ø25/Ø30** (348x84)



EVERGREEN

## SUPPORTI TENDA CURTAINS BRACKETS



**880**  
**Ø25/Ø30** (233x74)



**845**  
**Ø20x70** (94x60)      **Ø35x70** (109x60)  
**Ø20x120** (144x60)    **Ø35x120** (159x60)  
**Ø20x180** (204x60)    **Ø35x180** (219x60)

**Ø25x70** (99x60)  
**Ø25x120** (149x60)  
**Ø25x180** (209x60)

**Ø30x70** (104x60)  
**Ø30x120** (154x60)  
**Ø30x180** (214x60)



**888**  
**Ø25** (152x69)  
**Ø30** (157x69)  
**Ø35** (163x69)



**845 A**  
**Ø25x70** (104x60)      **Ø30x70** (110x60)  
**Ø25x120** (154x60)    **Ø30x120** (160x60)  
**Ø25x180** (214x60)    **Ø30x180** (220x60)

**Ø35x70** (115x60)  
**Ø35x120** (165x60)  
**Ø35x180** (225x60)



**874 dx/sx**  
 Ø16 (48x59)  
 Ø20 (48x61)  
 Ø25 (48x62)  
 Ø30 (48x65)



**874 A**  
 Ø16 (48x59)  
 Ø20 (48x61)  
 Ø25 (48x62)  
 Ø30 (48x65)



**861 A**  
 Ø11 (18x30)  
 Ø13 (18x30)  
 Ø25x30 (34x58)  
 Ø25x50 (34x58)  
 Ø30x30 (34x60)  
 Ø30x50 (34x60)



**861 dx/sx**  
 Ø11 (18x30)  
 Ø13 (18x30)  
 Ø25x30 (34x50)  
 Ø30x50 (34x88)



**844**  
 Ø11x20 (20x30)  
 Ø11x40 (20x50)  
 Ø11x70 (20x80)



Ø13x20 (20x30)  
 Ø13x40 (20x50)  
 Ø13x70 (20x80)



**865**  
 Ø16 (44x54)  
 Ø20 (48x64)  
 Ø25 (53x81)



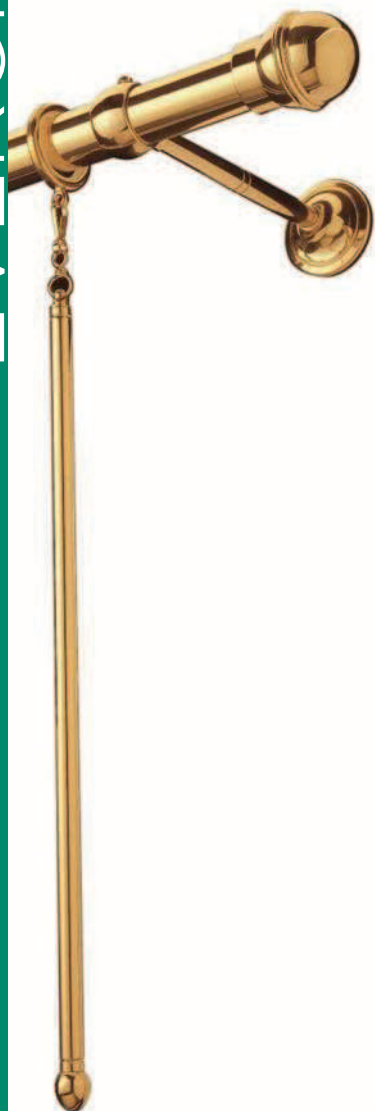

**1509**  
**25** (25x25)  
**35** (35x35)  
**45** (45x45)



**803**  
**Ø13** (19x45)  
**Ø18** (26x62)  
**Ø20** (28x68)  
**Ø25** (35x85)



**1506**  
**20** (25x24)  
**28** (32x24)  
**35** (38x27)  
**42** (45x33)  
**50** (54x33)



**1505**  
**20** (22x18)  
**28** (29x22)  
**35** (35x27)  
**42** (42x32)  
**50** (51x38)



**879**  
**1500** (16x1560)



**901**  
**Ø13** (25x32)  
**Ø20** (33x43)  
**Ø25** (41x51)  
**Ø30** (46x67)  
**Ø35** (52x63)  
**Ø40** (60x71)



**901 N**  
**Ø25** (41x51)  
**Ø30** (46x67)  
**Ø35** (52x63)  
**Ø40** (60x71)

L'anello in nylon rende più silenzioso lo scorrimento della tenda e preserva la finitura del tubo.

The nylon ring makes the sliding of the curtain quieter and protects the finish of the curtain rail.





**872**  
**120** (127x70)  
**180** (187x70)



**899**  
**120** (144x69)  
**180** (204x69)



**510**  
**85** (45x85)

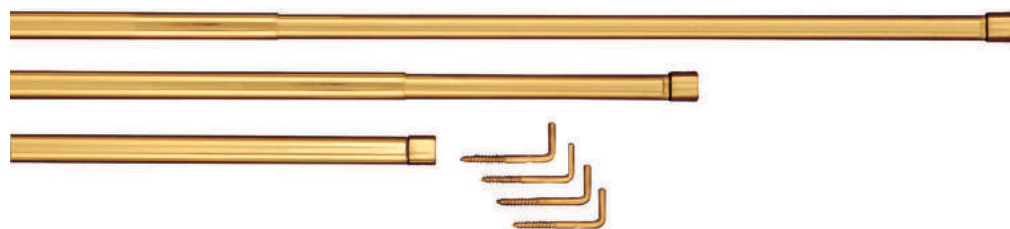

- 870**  
**30** (300/500)  
**40** (400/600)  
**50** (500/800)  
**60** (600/1000)



- 852 GI**  
**25** (60x25)  
**30** (60x30)  
**35** (60x35)  
**40** (60x40)

RACCORDO A SCOMPARSA  
 HIDDEN JOINT

TUBES



TUBES

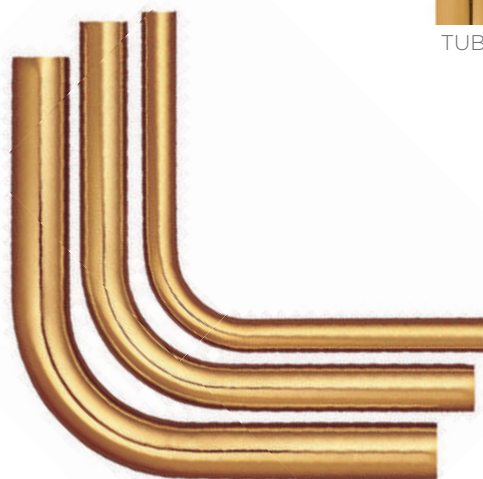

- 852 C90°**  
**Ø11** (125x125)  
**Ø13** (136x136)  
**Ø20** (189x189)  
**Ø25** (198x198)  
**Ø30** (214x214)  
**Ø35** (225x225)  
**Ø40** (288x288)



TUBI TUBES

**852**

<b>Ø9</b> (9x1500)	<b>Ø11</b> (11x1500)	<b>Ø13</b> (13x1500)
<b>Ø9</b> (9x2000)	<b>Ø11</b> (11x2000)	<b>Ø13</b> (13x2000)
<b>Ø9</b> (9x2500)	<b>Ø11</b> (11x2500)	<b>Ø13</b> (13x2500)
<b>Ø9</b> (9x3000)	<b>Ø11</b> (11x3000)	<b>Ø13</b> (13x3000)
<b>Ø9</b> (9x5000)	<b>Ø11</b> (11x5000)	<b>Ø13</b> (13x5000)
<b>Ø16</b> (16x1500)	<b>Ø20</b> (20x1500)	<b>Ø25</b> (25x1500)
<b>Ø16</b> (16x2000)	<b>Ø20</b> (20x2000)	<b>Ø25</b> (25x2000)
<b>Ø16</b> (16x2500)	<b>Ø20</b> (20x2500)	<b>Ø25</b> (25x2500)
<b>Ø16</b> (16x3000)	<b>Ø20</b> (20x3000)	<b>Ø25</b> (25x3000)
<b>Ø16</b> (16x5000)	<b>Ø20</b> (20x5000)	<b>Ø25</b> (25x5000)
<b>Ø30</b> (30x1500)	<b>Ø35</b> (35x1500)	<b>Ø40</b> (40x1500)
<b>Ø30</b> (30x2000)	<b>Ø35</b> (35x2000)	<b>Ø40</b> (40x2000)
<b>Ø30</b> (30x2500)	<b>Ø35</b> (35x2500)	<b>Ø40</b> (40x2500)
<b>Ø30</b> (30x3000)	<b>Ø35</b> (35x3000)	<b>Ø40</b> (40x3000)
<b>Ø30</b> (30x5000)	<b>Ø35</b> (35x5000)	<b>Ø40</b> (40x5000)



**852 R**

<b>Ø25</b> (25x2000)	<b>Ø30</b> (30x2000)	<b>Ø35</b> (35x2000)
<b>Ø25</b> (25x3000)	<b>Ø30</b> (30x3000)	<b>Ø35</b> (35x3000)
<b>Ø25</b> (25x5000)	<b>Ø30</b> (30x5000)	<b>Ø35</b> (35x5000)



FINALI END-KNOBS



**802**  
**25** (44x63)  
**30** (53x75)  
**35** (62x86)



**854**  
**20** (32x43)  
**25** (42x49)  
**30** (49x58)  
**35** (54x60)  
**40** (59x65)



**857**  
**20** (32x49)  
**25** (42x59)  
**30** (49x70)  
**35** (54x72)  
**40** (59x75)



**900**  
**20** (24x8)  
**25** (29x11)  
**30** (34x13)  
**35** (40x14)  
**40** (44x15)



**883**  
**Ø11** (20x21)  
**Ø13** (22x23)



**903**  
**Ø11** (14x14)  
**Ø13** (16x15)



**850**  
**Ø9** (9x9)  
**Ø11** (11x12)  
**Ø13** (13x13)  
**Ø16** (16x15)



**853**  
Ø20 (24x62)  
Ø25 (29x90)  
Ø30 (34x90)



**860**  
Ø10 (16x23)  
Ø12 (18x25)  
Ø14 (20x27)  
Ø17 (22x31)



**849**  
620 (620x30)  
820 (820x30)  
1020 (1020x30)

**851**

Ø9 (9x700)

Ø9 (9x800)

Ø9 (9x900)

Ø9 (9x1000)

Ø13 (13x700)

Ø13 (13x800)

Ø13 (13x900)

Ø13 (13x1000)

Ø13 (13x1100)

Ø11 (11x700)

Ø11 (11x800)

Ø11 (11x900)

Ø11 (11x1000)

Ø16 (16x900)

Ø16 (16x1000)

Ø16 (16x1100)

Ø16 (16x1200)

**868**

Ø12 (44x37)

Ø14 (44x37)

Ø16 (44x37)



EVERGREEN

ACCESSORI TENDE E SCALE CURTAINS AND STAIRS ACCESSORIES

SUPPORTI PER TENDE E SCALE CURTAINS AND STAIRS BRACKETS



**855**  
 Ø20 (50x71)  
 Ø25 (60x86)  
 Ø30 (69x94)  
 Ø35 (69x110)



**856**  
 Ø25 (60x86)  
 Ø30 (69x94)  
 Ø35 (69x109)



**858**  
 Ø30 (69x119)  
 Ø35 (69x124)  
 Ø40 (69x129)



SUPPORTI CORRIMANO HANDRAIL BRACKETS



**863**  
 Ø30 (69x116)  
 Ø35 (69x122)  
 Ø40 (69x127)



**863 E**  
 Ø30 (55x103)  
 Ø35 (55x108)  
 Ø40 (55x113)







**859**  
75 (69x77)



**859 E**  
65 (55x116)



**869**  
Ø20 (64x34)  
Ø25 (69x35)  
Ø30 (76x32)  
Ø35 (76x35)  
Ø40 (76x35)



**869 C**  
Ø20 (64x53)  
Ø25 (69x53)  
Ø30 (76x53)  
Ø35 (76x53)  
Ø40 (76x53)



RELING  
RELING





**840**

Ø11 (20x13)

Ø13 (23x15)

Ø16 (25x16)



**841 dx/sx**

Ø20 (31x17)

Ø25 (42x18)



**842**

Ø11 (15x20)

Ø13 (17x20)

Ø16 (20x20)

Ø20 (24x20)

Ø25 (29x20)

Ø30 (35x20)



**883**

Ø11 (20x21)

Ø13 (22x23)



**903**

Ø11 (14x14)

Ø13 (16x15)



**850**

Ø9 (9x9)

Ø11 (11x12)

Ø13 (13x13)

Ø16 (16x14)



**852**

Ø9 (9x1500)

Ø9 (9x2000)

Ø9 (9x2500)

Ø9 (9x3000)

Ø9 (9x5000)

Ø11 (11x1500)

Ø11 (11x2000)

Ø11 (11x2500)

Ø11 (11x3000)

Ø11 (11x5000)

Ø13 (13x1500)

Ø13 (13x2000)

Ø13 (13x2500)

Ø13 (13x3000)

Ø13 (13x5000)

Ø16 (16x1500)

Ø16 (16x2000)

Ø16 (16x2500)

Ø16 (16x3000)

Ø16 (16x5000)

Ø20 (20x1500)

Ø20 (20x2000)

Ø20 (20x2500)

Ø20 (20x3000)

Ø20 (20x5000)

Ø25 (25x1500)

Ø25 (25x2000)

Ø25 (25x2500)

Ø25 (25x3000)

Ø25 (25x5000)

Ø30 (30x1500)

Ø30 (30x2000)

Ø30 (30x2500)

Ø30 (30x3000)

Ø30 (30x5000)



**865**

Ø16 (44x54)



RELING RELING

SISTEMA RELING RELING SYSTEM



**2010**  
Ø16 (18x11)



**3075 C**  
Ø16 (94x94)



**2000**  
Ø16 (22x46)



**2001**  
Ø11x40 (14x40)      Ø11x70 (14x70)  
Ø13x40 (18x41)      Ø13x70 (18x70)  
Ø16x40 (20x45)      Ø16x70 (20x70)



**803**  
Ø13 (19x45)  
Ø18 (26x62)  
Ø20 (28x68)  
Ø25 (35x85)



**803 E**  
Ø18 (31x54)



**3075**  
Ø16 (16x1000)  
Ø16 (16x1500)  
Ø16 (16x2000)  
Ø16 (16x2500)  
Ø16 (16x3000)

EVERGREEN



RELING RELING

POGGIAPIEDI BRACKETS FOR FOOTREST

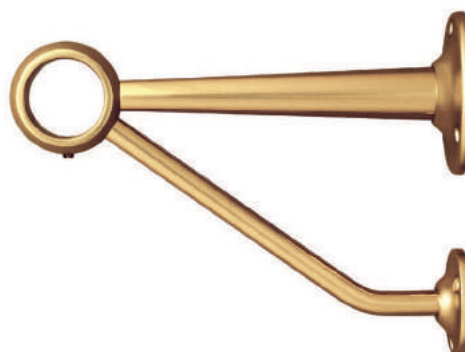

**1000**  
35 (211x211)

**1001**  
35 (211x160)

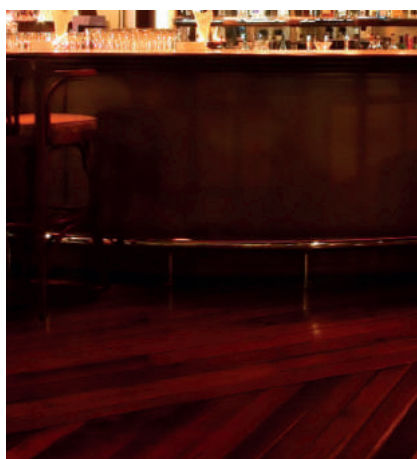

# MANIGLIE INCASSO FLUSH HANDLES



MANIGLIE INCASSO FLUSH HANDLES

MAGNETICHE MAGNETICS

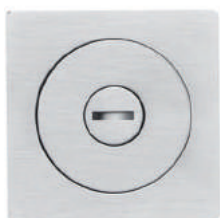
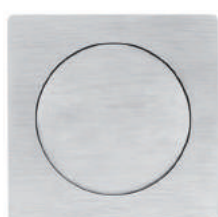
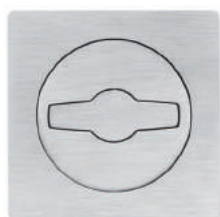

**590 AC Kit Pull**  
60 (57x57)

**590 Kit Pull**  
60 (57x57)

**592 Kit Pull**  
50 (52x52)

**592**  
50 (52x52)



**594**  
Ø30



**593**  
140 (45x140)  
160 (45x160)  
200 (45x200)





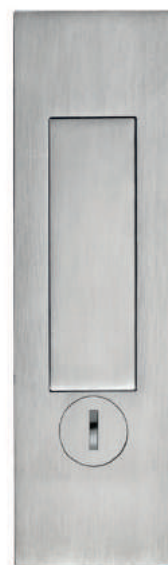

**593 Kit Pull**  
**140** (45x140)  
**160** (45x160)  
**200** (45x200)



**593 AC Kit Pull**  
**160** (45x160)



## MANIGLIE INCASSO FLUSH HANDLES

## MAGNETICHE MAGNETICS



**589 AC Kit Pull**  
Ø57



**589 Kit Pull**  
Ø57



**594 A**  
Ø60

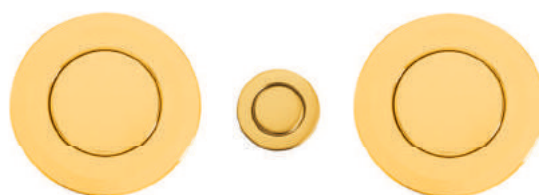

**594 A Kit Pull**  
Ø60



**594 C**  
Ø60

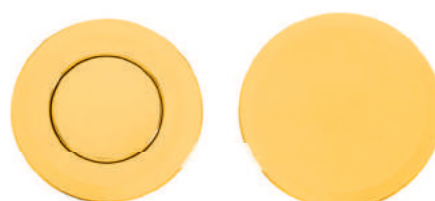

**594 B**  
Ø60



**598 OV FC**  
**128** (37x141)  
**160** (37x173)



**598 OV**  
**64** (37x76)  
**96** (37x109)  
**128** (37x141)  
**160** (37x173)



**595**  
 Ø30    Ø60  
 Ø40    Ø80  
 Ø50    Ø120  
 Ø55



**593 A FC**  
**140** (45x140)  
**160** (45x160)  
**200** (45x200)



**593 A**  
**140** (45x140)  
**160** (45x160)  
**200** (45x200)



**598 FC**  
**128** (42x142)  
**160** (42x174)



**598**  
**64** (42x78)  
**96** (42x110)  
**128** (42x142)  
**160** (42x174)



MANIGLIE INCASSO PER MOBILE CABINET FLUSH HANDLES



**596**  
**30** (29x29)  
**40** (39x39)  
**50** (52x52)  
**60** (60x60)



**588**  
**60** (47x66)



**580**  
 Ø50



**587**  
**40** (30x40)  
**50** (38x51)  
**60** (47x60)



**587 BA**  
**40** (30x40)  
**50** (38x51)  
**60** (47x60)



**595**  
 Ø30  
 Ø40  
 Ø50



**598**  
**64** (42x78)  
**96** (42x110)  
**128** (42x142)  
**160** (42x174)



**MANIGLIE VETRO  
HANDLES FOR  
GLASS DOORS**



**597 A**  
Ø60



**597 B**  
Ø60



**597 C**  
Ø60



**AI0464 V**  
160 (Ø16x200)  
192 (Ø16x232)  
256 (Ø16x296)



**AL0410 V**  
160 (14x174)  
192 (14x206)  
320 (14x334)

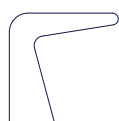

**AL0400 V**  
**160** (23x240)  
**320** (23x390)  
**448** (23x540)



**AL0401 V**  
**160** (16x240)  
**320** (16x390)  
**448** (16x540)

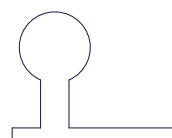

**AL0404 V**  
**160** (35x230)  
**320** (35x380)  
**448** (35x530)



**AL0408 V**  
**160** (10x260)  
**320** (10x410)  
**448** (10x560)



**538 V**  
**160** (14x174)  
**192** (14x206)  
**256** (14x270)



**APPENDIABITI  
E PORTACHIAVI  
COAT HANGERS  
AND HOTEL  
KEY-RINGS**







**1517**  
**35** (35x41)xh55



**AI1542**  
**14** (Ø35xh46)



**1516**  
**82** (82x43)



**1522**  
**31** (31x41)



**1504**  
**(200x41)**



**2070**  
**265** (265x95)

APPENDIABITI E PORTACHIAVI COAT HANGERS AND HOTEL KEY-RINGS



**C58000**  
(44x70)



**C58200**  
(34x74)



**C58100**  
(46x87)



**1540**  
(102x170)



**1535**  
(73x148)

PORTACHIAVI HOTEL KEY-RINGS



**511**  
**110** (36x80)



**510**  
**85** (45x85)



**REGGIPENSILI  
E REGGIMENSOLE  
WALL BRACKETS  
AND SHELF BRACKETS**

REGGIPENSILI WALL BRACKETS



**2025**  
**1000** (Ø20-35x1000)  
**1200** (Ø20-35x1200)

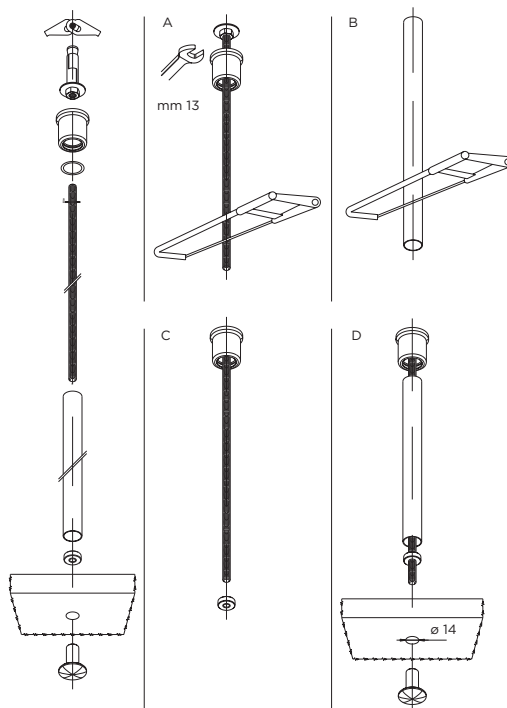

**AI2025**  
**1000** (Ø20-35x1000)  
**1200** (Ø20-35x1200)





**2001 M**

**6** (26x20)

**8** (26x20)

**10** (28x24)



**2000 M**

**8** (26x20)

**10** (28x24)



**PF2000**

**170** (170x99)



# ACCIAIO INOX STAINLESS STEEL





**AI0466**

- |                     |                     |
|---------------------|---------------------|
| <b>96</b> (116x10)  | <b>320</b> (340x10) |
| <b>128</b> (148x10) | <b>480</b> (500x10) |
| <b>160</b> (180x10) | <b>640</b> (660x10) |
| <b>192</b> (212x10) | <b>736</b> (756x10) |
| <b>224</b> (244x10) |                     |



**AI0450**

- 96** (117x10)
- 128** (150x10)
- 160** (183x10)
- 192** (222x10)
- 224** (258x10)
- 320** (370x10)



**AI0537**

- |                    |                     |
|--------------------|---------------------|
| <b>96</b> (104x8)  | <b>96</b> (106x10)  |
| <b>128</b> (136x8) | <b>128</b> (138x10) |
| <b>160</b> (168x8) | <b>160</b> (170x10) |
| <b>192</b> (200x8) | <b>192</b> (202x10) |
| <b>256</b> (264x8) | <b>320</b> (330x10) |
|                    | <b>480</b> (490x10) |



**AI0464 S**

- 96** (Ø12x176)
- 128** (Ø12x208)
- 160** (Ø12x240)
- 192** (Ø12x272)
- 224** (Ø12x304)
- 320** (Ø12x400)
- 352** (Ø12x432)
- 416** (Ø12x496)
- 448** (Ø12x528)
- 480** (Ø12x560)
- 640** (Ø12x720)
- 736** (Ø12x816)



**AI0470**

- 96** (106x16)
- 128** (138x16)
- 160** (172x20)
- 192** (204x20)
- 320** (332x20)



**AI0181**  
**20** (20x24)  
**24** (24x29)



**AI0180**  
**20** (20x22)  
**25** (25x27)  
**30** (30x32)



**AI0153**  
**15** (15x22)  
**18** (18x24)  
**21** (21x27)

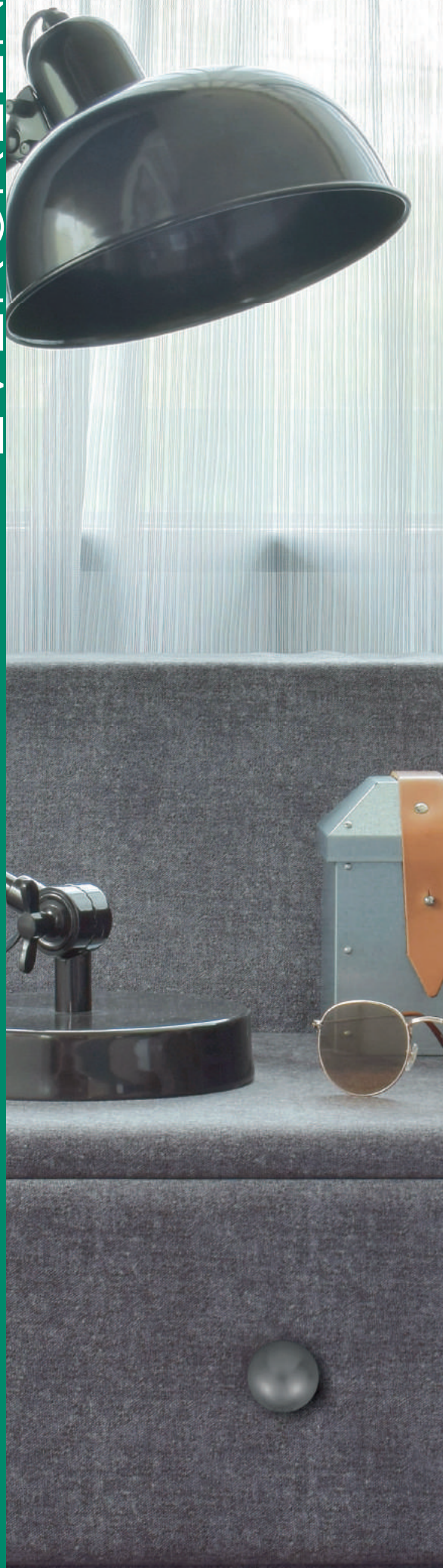



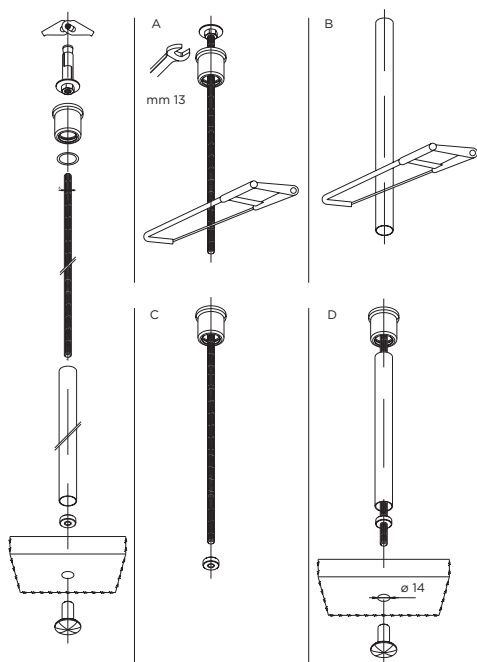

**AI2025**  
**1000** (Ø20-35x1000)  
**1200** (Ø20-35x1200)



**AI1542**  
**14** (Ø35xh46)

# ALLUMINIO ALUMINIUM





**AL0410**

- 160** (14x174)
- 192** (14x206)
- 320** (14x334)
- 448** (14x462)
- 640** (14x654)
- 736** (14x750)



**AL0409**

- 128** (16x140)
- 160** (16x172)
- 192** (16x204)
- 224** (16x236)
- 256** (16x268)
- 320** (16x332)
- 352** (16x364)
- 448** (16x460)
- 512** (16x524)
- 640** (16x652)
- 800** (16x812)



**AL0411**

- 160** (174x30)
- 224** (238x30)
- 320** (334x30)
- 640** (654x30)



**AL0412**

- 160** (195x28)
- 224** (269x28)
- 320** (377x28)
- 640** (757x28)



**AL0413**

- 160** (225x22)
- 224** (288x22)
- 320** (383x22)
- 640** (702x22)
- 800** (861x22)

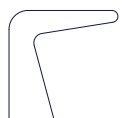

**AL0400**

- 160** (23x240)
- 320** (23x390)
- 448** (23x540)
- 640** (23x740)
- 736** (23x840)



**AL0401**

- 160** (16x240)
- 320** (16x390)
- 448** (16x540)
- 640** (16x740)
- 736** (16x840)

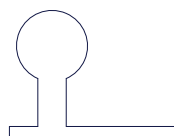

**AL0404**

- 160** (35x230)
- 320** (35x380)
- 448** (35x530)
- 640** (35x730)
- 736** (35x830)



**AL0408**

- 160** (10x260)
- 320** (10x410)
- 448** (10x560)
- 640** (10x760)
- 736** (10x860)



MANIGLIA ALLUMINIO INCASSO PER MOBILE ALUMINIUM CABINET FLUSH HANDLE



**AL0599**

**128** (128x36)

**160** (160x36)

**200** (200x36)

POMOLO ALLUMINIO PER MOBILE ALUMINIUM CABINET KNOB



**AL0192**

**15** (22x15)

**20** (30x20)



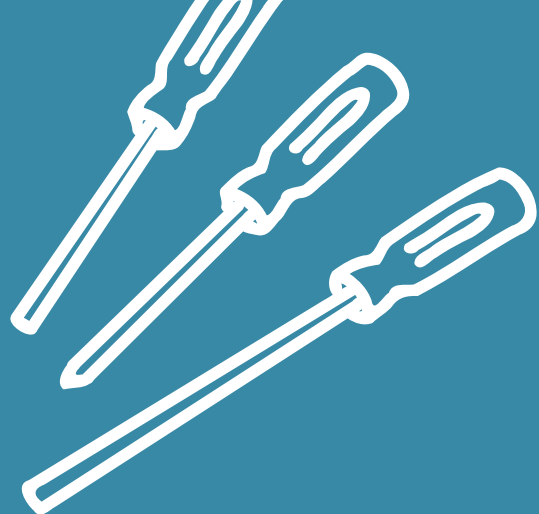
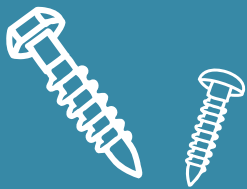

# ACCESSORI ACCESSORIES

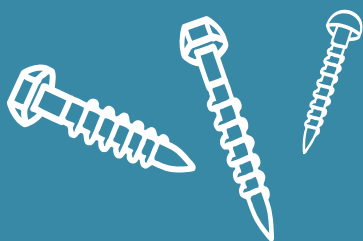
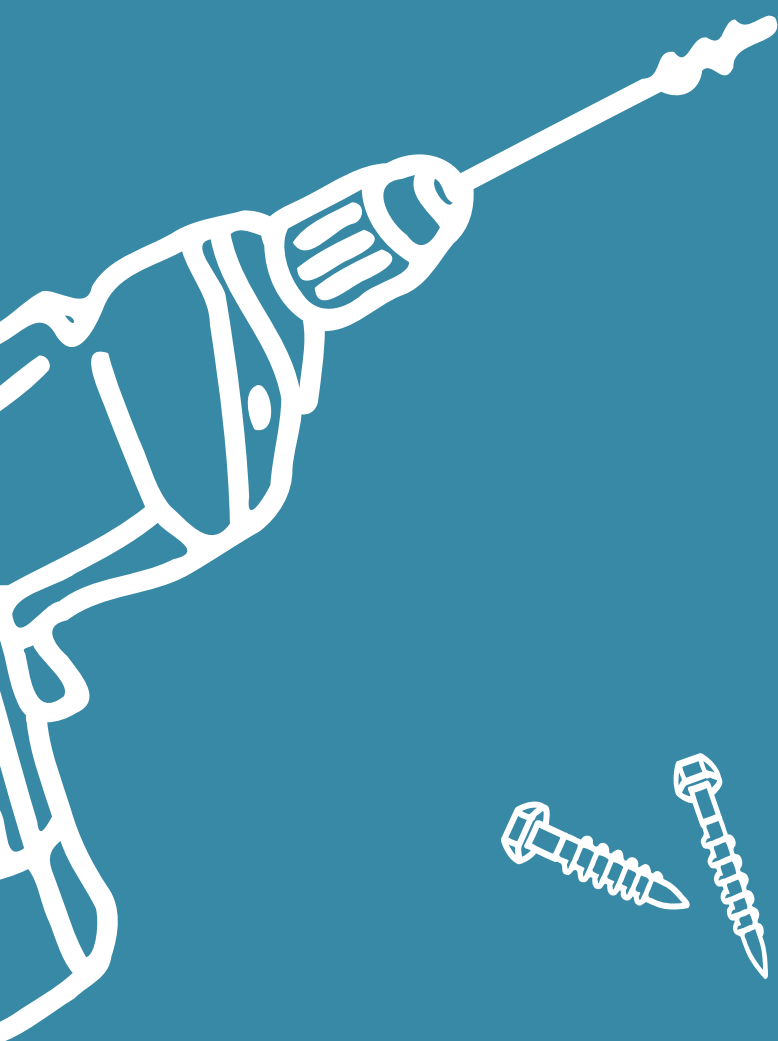



**\*CV001**  
(31x13)



**SV**  
**075** (25xM4)  
**080** (50xM4)  
**081** (55xM4)



**852 GI**  
**25** (60x25)  
**30** (60x30)  
**35** (60x35)  
**40** (60x40)



**AP04**  
**72** (72x25)



**AP01**  
**65** (126x95)



**AP02**  
**60** (60x60)



**SV114**  
17



**SV128**  
(45xM4)



SOLO METALLI NOBILI  
E LAVORAZIONI  
ACCURATE

ONLY NOBLE METALS  
AND DETAILED  
MANUFACTURING



**STAMPAGGIO  
A CALDO**



**HOT  
FORGING**

La tecnologia dello stampaggio a caldo ha preso il posto della tradizionale fusione in quanto consente di ottenere prodotti con forme complesse e una qualità costante.

Hot forging replaced the traditional metal casting process, since it allows producing more consistent and higher quality products.

**PVD  
(PHYSICAL VAPOUR  
DEPOSITION)**



**PVD  
(PHYSICAL VAPOUR  
DEPOSITION)**

Processo di deposizione molecolare in condizioni di alto vuoto e ad alte temperature, conferisce ai nostri prodotti un'elevatissima resistenza agli agenti chimici e atmosferici e illimitata resistenza all'ossidazione. La resistenza antigraffio è di 4 volte superiore ai normali rivestimenti galvanici.

Physical Vapour Deposition, or molecular deposition process in high vacuum conditions and at high temperatures, gives our products an extreme resistance to chemical agents and meteorological elements, as well as unlimited resistance to oxidation. Anti-scratch resistance is 4 times higher than what is yielded by standard galvanized coating.

**CESELLATURA**



**CHISELLING**

Nonostante l'uso di stampi, siano essi gli storici o i più moderni delle collezioni contemporanee, alcuni particolari decorativi richiedono ancora la mano esperta del Mastro Cesellatore che va a rifinire e portare al dovuto risalto i particolari più minuti ottenendo un vero e proprio «pezzo d'arte» unico e immediatamente distinguibile.

Despite the use of molds, whether from historical or more contemporary collections, some decorative details still require the expert hand of the Master Chiseller, who refines and enhances the smallest details, thus producing a true, unique and immediately recognizable "art piece".

## DIAMANTATURA



## DIAMOND DRESSING

Facciamo «brillare» i nostri prodotti come un gioiello prezioso con questa lavorazione che consente di ottenere purezza geometrica, planarità delle superfici e un'estrema luminosità utilizzando, allo scopo, un diamante grezzo.

We give our products the "brightness" of precious jewels. Polishing objects with a rough diamond gives our products geometric purity, flat surfaces and extreme brightness.

## LAVORAZIONE ARTIGIANALE



## CRAFTSMANSHIP

Ai nostri complementi applichiamo tecniche di produzione e di finitura altamente tecnologiche ma ci sono oggetti che richiedono, ancora, tutta la maestria artigiana - maturata in 70 anni di storia - per ricevere finiture specifiche e manuali quali, ad esempio, le sfumature delle finiture in oro antico.

To our products, we apply state-of-the-art manufacture and finishing techniques. However, some items still require the employment of the craftsmanship we honed in 70 years of activity, such as, for instance, antique gold finish shading.

## MAGNETE



## MAGNET

Un brevetto con magneti al neodimio, esclusivo e registrato da Officine Meccaniche Porro, e le nostre maniglie - da incasso a levitazione - diventano silenziosissime e inalterabili nel tempo.

Officine Meccaniche Porro have patented a magnetic levitation mechanism that, thanks to neodymium magnets integrated inside flush handles, makes them extremely quiet to operate and durable over time.



## QUALITÀ

Metalli nobili, tecnologie d'avanguardia e brevetti esclusivi, per una produzione di complementi per mobili, tende e scale di qualità superiore.

## ASSORTIMENTO

Oltre 20.000 referenze per adattarsi a tutte le possibili esigenze sia in termini di stile che di scelta dei materiali.

## LAVORAZIONI

Attente e rigorose lavorazioni controllate passo per passo, per garantire prodotti belli da vedere e con una durata nel tempo ineguagliabile.

## FINITURE

Finiture con tecnologie di punta o manuali perché ogni prodotto Alfredo Porro sia all'altezza delle più elevate aspettative.

## MISURE

Le misure sono espresse in millimetri. Le misure degli articoli indicate nel catalogo possono subire lievi modifiche di perfezionamento.

## 100% MADE IN ITALY

Tutti i complementi per mobili, tende e scale della linea Alfredo Porro - come tutta la produzione Officine Meccaniche Porro - sono garantiti come interamente concepiti e realizzati in Italia.

## QUALITY

We only use noble metals, cutting-edge technology and exclusive patents to manufacture superior quality accessories for furniture, curtains and stairs.

## RICH INVENTORY

More than 20.000 references to meet all of our customers' needs, both in terms of style and selection of materials.

## PRODUCTION PROCESSES

Accurate and rigorous production processes and a step-by-step quality control - that is how we can guarantee products that are as beautiful as they are durable over time.

## FINISHES

Finishes that rely upon cutting-edge technology, as well as manual work: each Alfredo Porro product must meet the most demanding expectations.

## MEASUREMENTS

All dimensions are in millimeters. Item's dimensions indicated in the price list could vary slightly according to the finished products' requirements.

## 100% MADE IN ITALY

Like the entire Officine Meccaniche Porro catalog, all Alfredo Porro accessories for furniture, curtains and stairs are entirely designed and manufactured in Italy.



## FINITURE A LISTINO PRICE LIST FINISHING

---



Oro Lucido

Polished Brass



Bronzo Antico

Antique Bronze



Bronzo Antico  
Etrusco

Etruscan Antique  
Bronze



Ottone Antico

Ancient Brass



Oro Antico

Old Gold



Nickel Lucido

Nickel Plated



Nickel Satinato

Satin Nickel



Cromo Lucido

Chrome Plated



Cromo Satinato

Satin Chrome

## ACCIAIO INOX STAINLESS STEEL

---



Acciaio Lucido

Bright  
Stainless Steel



Acciaio Satinato

Satin  
Stainless Steel

## ALLUMINIO ALUMINIUM

---



Alluminio Cromato

Chrome  
Aluminium



Alluminio Anodizzato

Anodised  
Aluminium



Alluminio Anodizzato  
Inox

Inox Anodised  
Aluminium

## FINITURE A RICHIESTA FINISHING ON DEMAND

---



Oro Non  
Verniciato  
Polished Brass  
Not Lacquered



Oro PVD  
Polished Brass  
PVD



Bagno Oro  
Gold Plated



Bagno Oro  
PVD  
Gold PVD



Oro Antico  
PVD  
Old Gold  
PVD



Oro Imperiale  
Imperial Gold



Oro Satinato  
Satin Brass



Argento Vecchio  
Antique Silver



Patined Steel



Oil Rubbed  
Bronze



Bagno Argento

Silver Plated



Matt Black/Matt White

---

### I COLORI DELLE FINITURE SONO INDICATIVI

Alcune finiture vengono eseguite manualmente e pertanto possono presentare variazioni di tonalità e sfumatura creando doti di unicità e bellezza del prodotto.

### THE COLOURS OF THE FINISHES ARE INDICATIVE

Some of the finishes are performed manually therefore variations in colour tone and shading may occur giving beauty and uniqueness to the product.











Credits

Progetto grafico / Graphic design  
Adf&R S.r.l. Milano

Impaginazione / Layout  
Adf&R S.r.l. Milano  
OMP PORRO S.r.l.

Stampa / Printing  
Arti Grafiche Meroni S.r.l.

Foto / Pictures  
- I.K.B.  
- Mimmo Capurso



# ALFREDO PORRO



MANUFACTURED BY OFFICINE MECCANICHE PORRO

omporro

officine meccaniche porro

**OMP PORRO S.r.l**

22060 Cucciago (CO) ITALY - via Stazione, 8/a  
tel. +39 031.787100 r.a. - fax +39 031.787575

info@omporro.eu  
alfredoporro.it